

P504

Полкодержатель для полок толщиной до 8 мм. Максимальная нагрузка (на пару) - 25 кг / The Holder for shelf from a glass or others material of thickness up to 8 mm or less. Maximum bearing capacity (for pair) up to 25 kg

код / code	упаковка (шт.) / packing (pcs.)	упаковка (шт.) / packing (pcs.)
P504GP.2	43	40
P504CP.2	43	40
P504SC.2	43	40
P504SN.2	43	40
P504BSN.2	43	40
P504AB.2	43	40

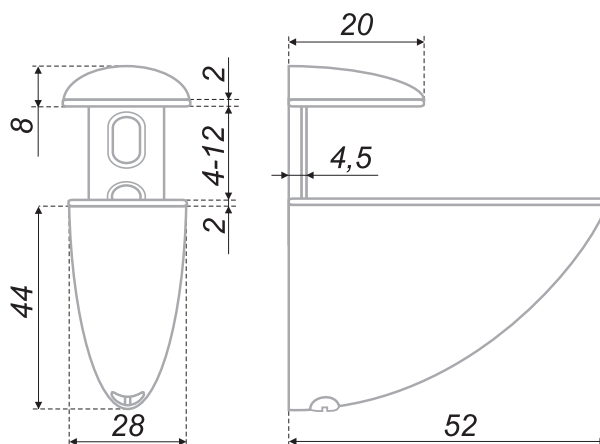

P505

Полкодержатель для полок толщиной до 12 мм. Максимальная нагрузка (на пару) - 37,5 кг / The Holder for shelf from a glass or others material of thickness up to 12 mm or less. Maximum bearing capacity (for pair) up to 37,5 kg

код / code	упаковка (шт.) / packing (pcs.)	упаковка (шт.) / packing (pcs.)
P505GP.2	73	25
P505CP.2	73	25
P505SC.2	73	25
P505SN.2	73	25
P505BSN.2	73	25
P505AB.2	73	25

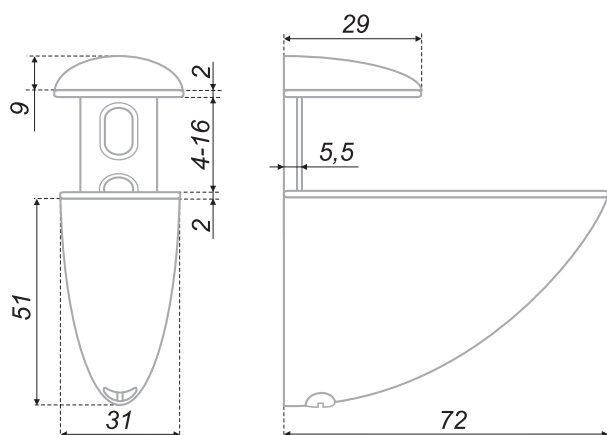

P506





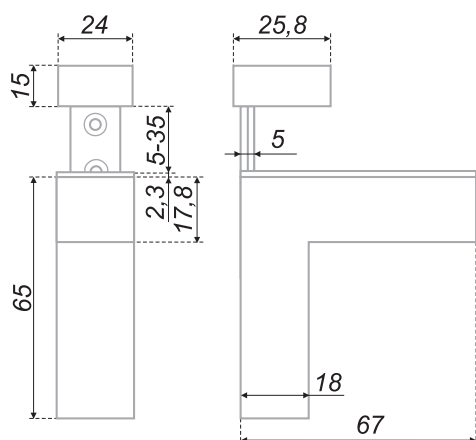

Полкодержатель для полок толщиной до 16 мм. Максимальная нагрузка (на пару) - 40 кг / The Holder for shelf from a glass or others material of thickness up to 16 mm or less. Maximum bearing capacity (for pair) up to 40 kg

код / code	 упаковка (шт.) / packing (pcs.)
 P506GP.2	116 10
 P506CP.2	116 10
 P506SC.2	116 10
 P506SN.2	116 10
 P506BSN.2	116 10
 P506AB.2	116 10



P507

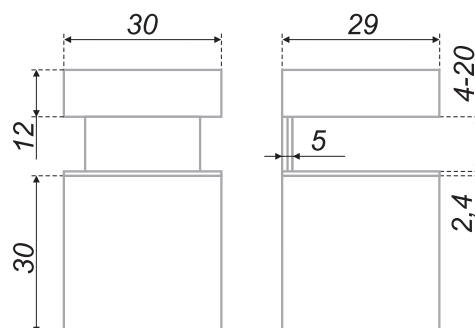

Полкодержатель для полок толщиной до 35 мм. Максимальная нагрузка (на пару) - 40 кг / The Holder for shelf from a glass or others material of thickness up to 35 mm or less. Maximum bearing capacity (for pair) up to 40 kg

код / code	 упаковка (шт.) / packing (pcs.)
 P507GP.2	193 15
 P507CP.2	193 15
 P507SC.2	193 15
 P507SN.2	193 15
 P507BSN.2	193 15
 P507AB.2	193 15



P509

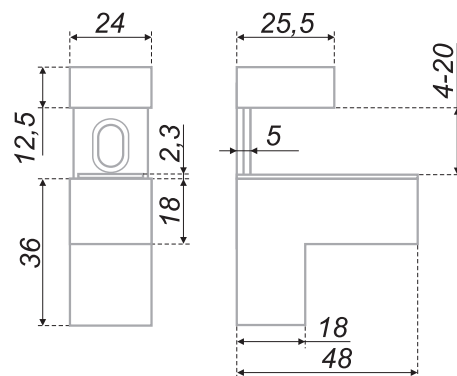

Полкодержатель для полок толщиной до 20 мм. Максимальная нагрузка (на пару) - 25 кг / The Holder for shelf from a glass or others material of thickness up to 20 mm or less. Maximum bearing capacity (for pair) up to 25 kg

код / code	 упаковка (шт.) / packing (pcs.)	упаковка (шт.) / packing (pcs.)
 P509CP.2	120	24
 P509SC.2	120	24



P510

Полкодержатель для полок толщиной до 20 мм. Максимальная нагрузка (на пару) - 25 кг / The Holder for shelf from a glass or others material of thickness up to 20 mm or less. Maximum bearing capacity (for pair) up to 25 kg

код / code	 упаковка (шт.) / packing (pcs.)	упаковка (шт.) / packing (pcs.)
 P510CP.2	116	20
 P510SC.2	116	20

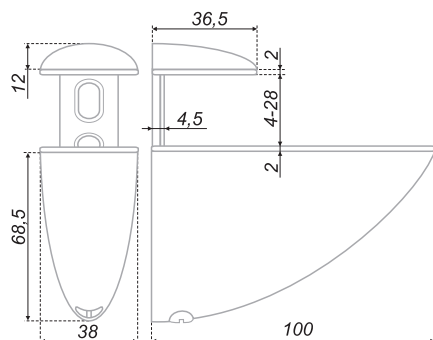

P511



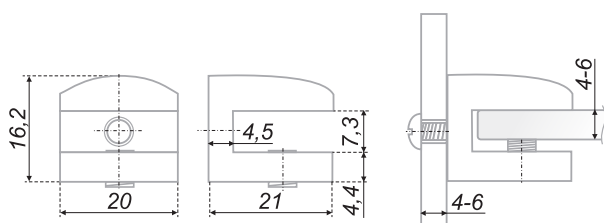

Полкодержатель для полок толщиной до 28 мм. Максимальная нагрузка (на пару) - 50 кг / The Holder for shelf from a glass or others material of thickness up to 28 mm or less. Maximum bearing capacity (for pair) up to 50 kg

код / code	 упаковка (шт.) / packing (pcs.)
 P511GP.2	195 10
 P511CP.2	195 10
 P511SC.2	195 10
 P511SN.2	195 10
 P511BSN.2	195 10
 P511AB.2	195 10



P512



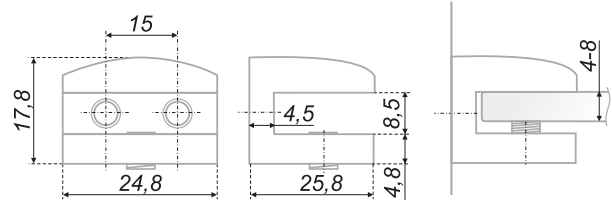

Полкодержатель металлический с регулируемым фиксатором для полок толщиной до 6 мм, нагрузка (на пару) - 15 кг / Metal shelf support with adjustable clip for shelves up to 6 mm, the load capacity (per pair) - 15 kg

код / code	 упаковка (шт.) / packing (pcs.)
 P512GP.2	32 50
 P512CP.2	32 50
 P512AB.2	32 50
 P512SN.2	32 50



P513



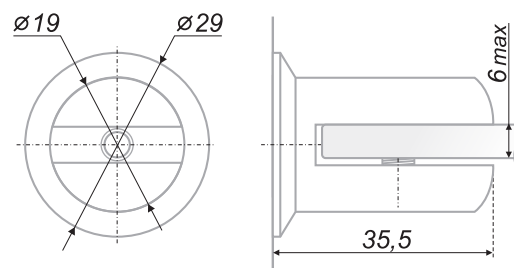

Полкодержатель металлический с регулируемым фиксатором для полок толщиной до 8 мм, нагрузка (на пару) - 15 кг /
Metal shelf support with adjustable clip for shelves with thickness up to 8 mm, the load capacity (per pair) - 15 kg

код / code	 упаковка (шт.) / packing (pcs.)	упаковка (шт.) / packing (pcs.)
 P513GP.2	50	30
 P513CP.2	50	30
 P513AB.2	50	30
 P513SN.2	50	30



P514



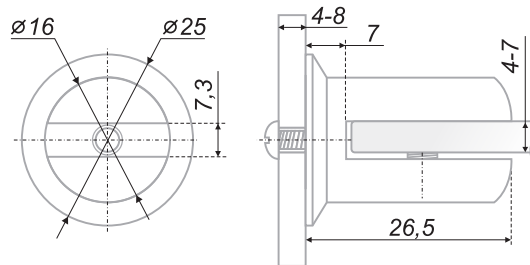

Полкодержатель металлический с регулируемым фиксатором для полок толщиной до 6 мм, нагрузка на пару - 15 кг /
Shelf support with adjustable metal clip for shelves to 6 mm thick, the load capacity on a pair - 15 kg

код / code	 упаковка (шт.) / packing (pcs.)	упаковка (шт.) / packing (pcs.)
 P514GP.2	62	30
 P514CP.2	62	30
 P514AB.2	62	30
 P514SN.2	62	30



P515

Полкодержатель металлический с регулируемым фиксатором для полок толщиной до 7 мм, нагрузка на пару - 15 кг /
Shelf support with adjustable metal clip for shelves with thickness up to 7 mm, load capacity for a pair - 15 kg

код / code	 упаковка (шт.) / packing (pcs.)
 P515GP.2	29 40
 P515CP.2	29 40
 P515AB.2	29 40
 P515SN.2	29 40

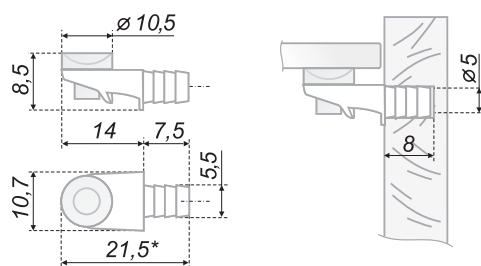

P001

Полкодержатель металлический с вакуумной присоской из ПВХ, для стеклянных полок /
Metal holder with a PVC vacuum cup, for the glass shelves

код / code	 упаковка (шт.) / packing (pcs.)
 P001NP.57	2 10 000

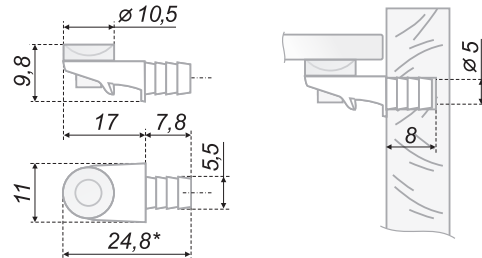

P002

Полкодержатель металлический с вакуумной присоской из ПВХ, для стеклянных полок /
Metal holder with a PVC vacuum cup, for the glass shelves

код / code	 упаковка (шт.) / packing (pcs.)
 P002NP.58	4 5 000

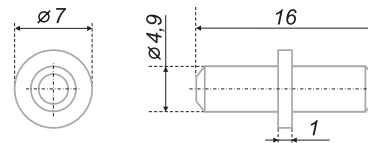

P101

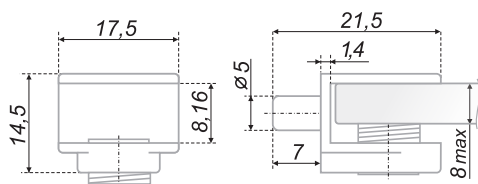

Полкодержатель металлический, оцинкованный, вставной (типа «штифт») /
Metal zink-coated holder, insert («pin»-mode)

код / code	 упаковка (шт.) / packing (pcs.)
 P101Zn.56	2 5 000



P401

Полкодержатель металлический с регулируемым фиксатором толщиной до 8 мм /
The holder with the adjustable retainer clip for the shelves made of glass and other materials up to 8 mm thick

код / code	 упаковка (шт.) / packing (pcs.)
 P401Ni.60	7 20 000
 P401CP.60	7 20 000

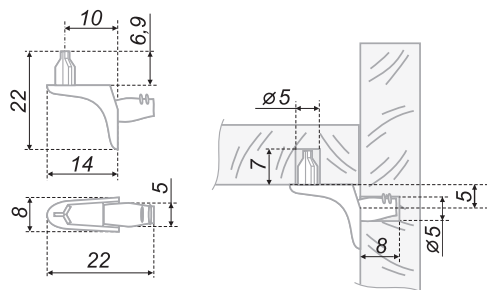

P901

Полкодержатель металлический с фиксирующим трехгранным штифтом /
Metal holder with a fixed three-edged pin

код / code	 упаковка (шт.) / packing (pcs.)
 P901Ni.59	3 2 500